

ELAD FDM-S3

Direct Sampling Wideband Receiver

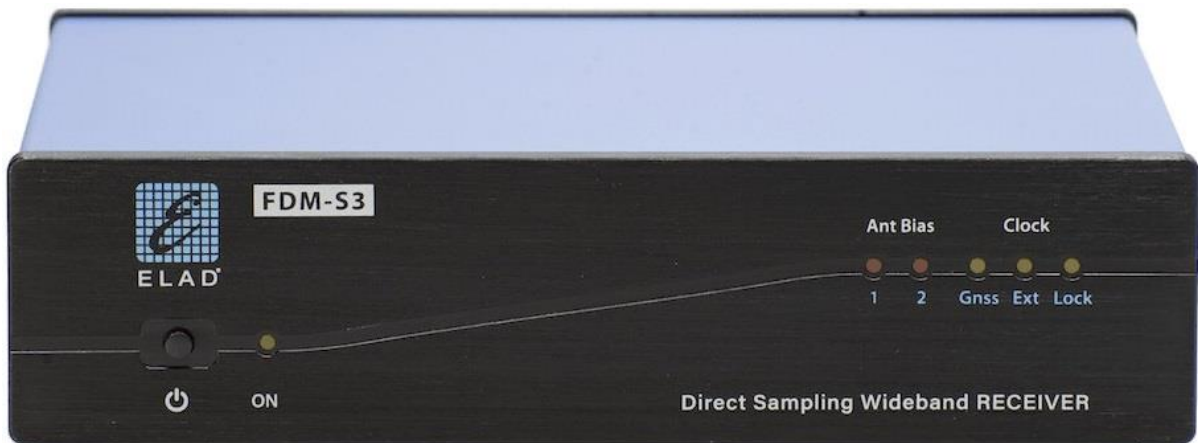

USER MANUAL

Contents

Revision History	3
Package Contents.....	4
1 Introduction	5
1.1 Overview	5
1.2 Reference Clock Manager Module	6
1.3 Features	7
1.4 Requirements.....	7
1.5 Front End Block Diagram.....	8
2 Panels Description.....	9
2.1 Front Panel Description	9
2.2 Rear Panel Description.....	10
3 Optional Preselector Filters	12
3.1 List of Available Filters	13
3.2 Slots Access	14
3.3 Inserting Filters	15
3.4 Enabling the Configuration	16
4 USB COM Ports.....	17
4.1 Reference Clock Manager Module COM Port.....	17
4.2 Internal Gnss module COM Port	18
5 Order Options	19
5.1 Oscillator Version	19
5.2 Preselector Filters	19
5.3 Downconverter Module.....	19
Technical Specifications	20
Product Warranty	21
Declaration of Conformity (EC)	22
Declaration of Conformity (FCC)	23

Revision History

Revision	Date	Description
Rev 1	10/2020	<ul style="list-style-type: none"> • First revision.
Rev 2	10/2020	<ul style="list-style-type: none"> • Minor corrections on some descriptions. • Revised section 1.1 - Overview. • Revised section 1.3 - Features. • Revised section 3 - Optional Preselector Filters.
Rev 3	10/2020	<ul style="list-style-type: none"> • Added section 1.5 - Front End Block Diagram. • Added section 4 - USB COM Ports. • Updated Technical Specifications to rev 2.
Rev 4	10/2020	<ul style="list-style-type: none"> • Fixed section 1.3 - Features : <ul style="list-style-type: none"> ○ the HF bias is on HF-2, not HF-1, ○ added the maximum current deliverable for biases. • Updated rear panel description. • Updated section 3 - Optional Preselector Filters. • Updated ports presentation in section 4 - USB COM Ports.
Rev 4.1	06/2021	<ul style="list-style-type: none"> • Minor corrections on some descriptions.
Rev 4.2	11/2022	<ul style="list-style-type: none"> • Added information regarding the Downconverter Module.
Rev 4.3	11/2022	<ul style="list-style-type: none"> • Updated section 5.3 - Downconverter Module.

Package Contents

- 1 ELAD FDM-S3.
- 3 SMA/BNC adapters.
- 1 USB flash drive.
- 1 DC power cord (Powerpole to open wires).
- 1 USB 3.0 A-B cable.
- 1 GNSS antenna. (*)



(*) The Gnss antenna is not supplied with all versions, please check ELAD websites for details.

1 Introduction

1.1 Overview

The FDM-S3 is the third device of the FDM-Sx series, in addition to the usual 192kHz, 384kHz, 1.5MHz, 3MHz and 6MHz bandwidths it features two additional **bandwidths of 12MHz and 24MHz**. Frequency coverage range is from **9kHz to 108MHz** with pre-amplifier and internal filter for the FM band, an optional downconverter will be soon available to extend frequency covering range over 108MHz.

Two versions of the FDM-S3 with different oscillator characteristics are available:

- version with TCXO (*Temperature Compensated Crystal Oscillator*), with a good frequency stability and a lower power consumption,
- version with OCXO (*Oven Controlled Crystal Oscillator*), with a higher degree of frequency stability but also a higher power consumption.

The FDM-S3 embeds a 16 bits AD converter (LTC2208) which runs at a **variable sample rate** of 122.88MHz or 98.304MHz. This technique allows to choose the better sample rate in function of the tuning frequency.

Even if the maximum frequency declared is 108MHz, tuning is left open above 108MHz for experimental purposes. The following table summarizes some information about the FDM-S3 behavior in function of the RF input chosen and the tuned frequency.

RF Input	Tuned Frequency	Sample Rate	Internal Path
HF-1 / HF-2	9kHz to 54MHz	122.88MHz	LP filter + preselector filters
VHF	54MHz to 68.88MHz	98.304MHz	Bypass + preamp
VHF	68.88MHz to 108MHz	122.88MHz	FM filter + preamp
VHF	108MHz to 147MHz	98.304MHz	Bypass + preamp
VHF	147MHz to 500MHz	122.88MHz	Bypass + preamp
RF-IN (Downconverter)*	108MHz a 4.25GHz	122.88MHz	Bypass + preamp

* the frequency range 54MHz - 68.88MHz is not currently managed when the Downconverter is inserted.

The table below shows the availability of the variable sample rate feature in relation to bandwidths.

Bandwidth	192 kHz	384 kHz	1 536 kHz	3 072 kHz	6 144 kHz	12 288 kHz	24 576 kHz
Variable SR	yes	yes	yes	yes	yes	no	no

Note that tuning between 54MHz and 68.88MHz with 12MHz and 24MHz bandwidths is not recommended.

1.2 Reference Clock Manager Module

The FDM-S3 has a so-called **Reference Clock Manager Module** (RCMM) which allows to choose between two reference clocks:

- a GnsDO (*Global navigation satellite system Disciplined Oscillator*) which is compatible with the main satellite constellations (GPS, GLONASS, Galileo, BeiDou),
- a 10MHz/0dBm external signal.

Reference clock activation is automatic, just connect the Gns antenna or provide a 10MHz signal. If both inputs are used priority is given to the 10MHz signal. Three leds on the front panel allow to check the reference used and the **lock state** of the Reference Clock Manager Module.

If no reference clock is used a **factory calibration** ensures a correct setting of the internal oscillator. This calibration value is loaded and used at start-up but is bypassed if a reference clock (GnsDO or 10MHz) is connected.

If used without reference clock (RCMM not locked) the FDM-S3 has a frequency calibration less than ± 0.1 ppm. If used with a reference clock (RCMM locked), characteristics depend on the oscillator version:

- with TCXO (*Temperature Compensated Crystal Oscillator*):
 - frequency stability: ± 0.1 ppm vs. temp, ± 1 ppm/year vs. aging,
- with OCXO (*Oven Controlled Crystal Oscillator*):
 - frequency stability: ± 0.01 ppm vs. temp, ± 0.05 ppm/year vs. aging,
 - 10 minutes' warm-up,
 - Allan deviation: TBD.

1.3 Features

An **integrated USB hub** allows to have only one USB 3.0 connector that provides three USB connections to:

- the ELAD FDM-S3 sampler, used by the FDM-SW2 software,
- the USB COM Port of the Reference Clock Manager Module, some information about status are supplied with a proprietary protocol,
- the USB COM Port of the internal Gns (global navigation satellite system) module, which can be connected to the u-center software from u-blox (or equivalent software), the protocol used is **NMEA**.

The FDM-S3 has **two antenna biases**, one for the **HF-2 input** and one for the **VHF input**. The supplied voltage is 5V (max 150mA). They are activated and deactivated via the FDM-SW2 software. Two leds on the front panel allow to check the biases status. Antennas biases can be managed through the **Tuning Step** tab of the **Setup** window of the FDM-SW2 software.

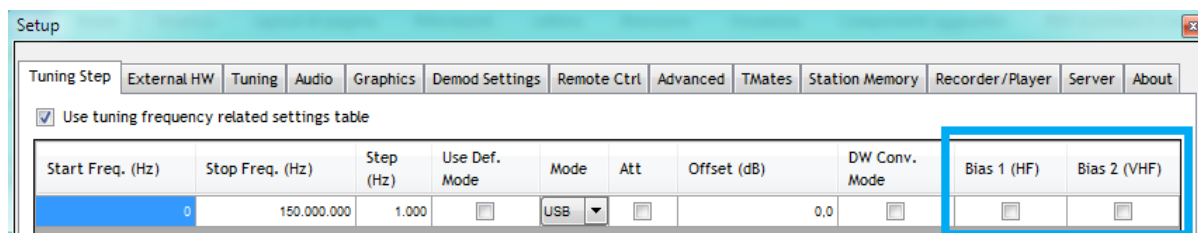

The FDM-S3 has also eight slots for **preselector filters** that can be used on HF-1 and HF-2 inputs (from 9kHz to 54MHz). These filters are **optional**, therefore the FDM-S3 is shipped with a bypass filter.

A series of attenuators allow to have up to **four levels of attenuation**: 0dB, 6dB, 12dB and 18dB.

1.4 Requirements

An USB 3.0 port is required to connect the FDM-S3 to a computer.

Computer requirements to run the FDM-SW2 software with the FDM-S3 **at 24MHz** are the following:

- suggested configuration: 8th generation or higher Intel Core i5/i7 (or equivalent) processor and 16GB of RAM,
- minimum recommended: 5th/6th/7th generation Intel Core i5/i7 (or equivalent) processor and 8GB of RAM.

To recording **at 24MHz** of bandwidth a SSD with at least 250MB/s write speed is recommended.

1.5 Front End Block Diagram

The diagram below shows the front end block diagram of the FDM-S3.

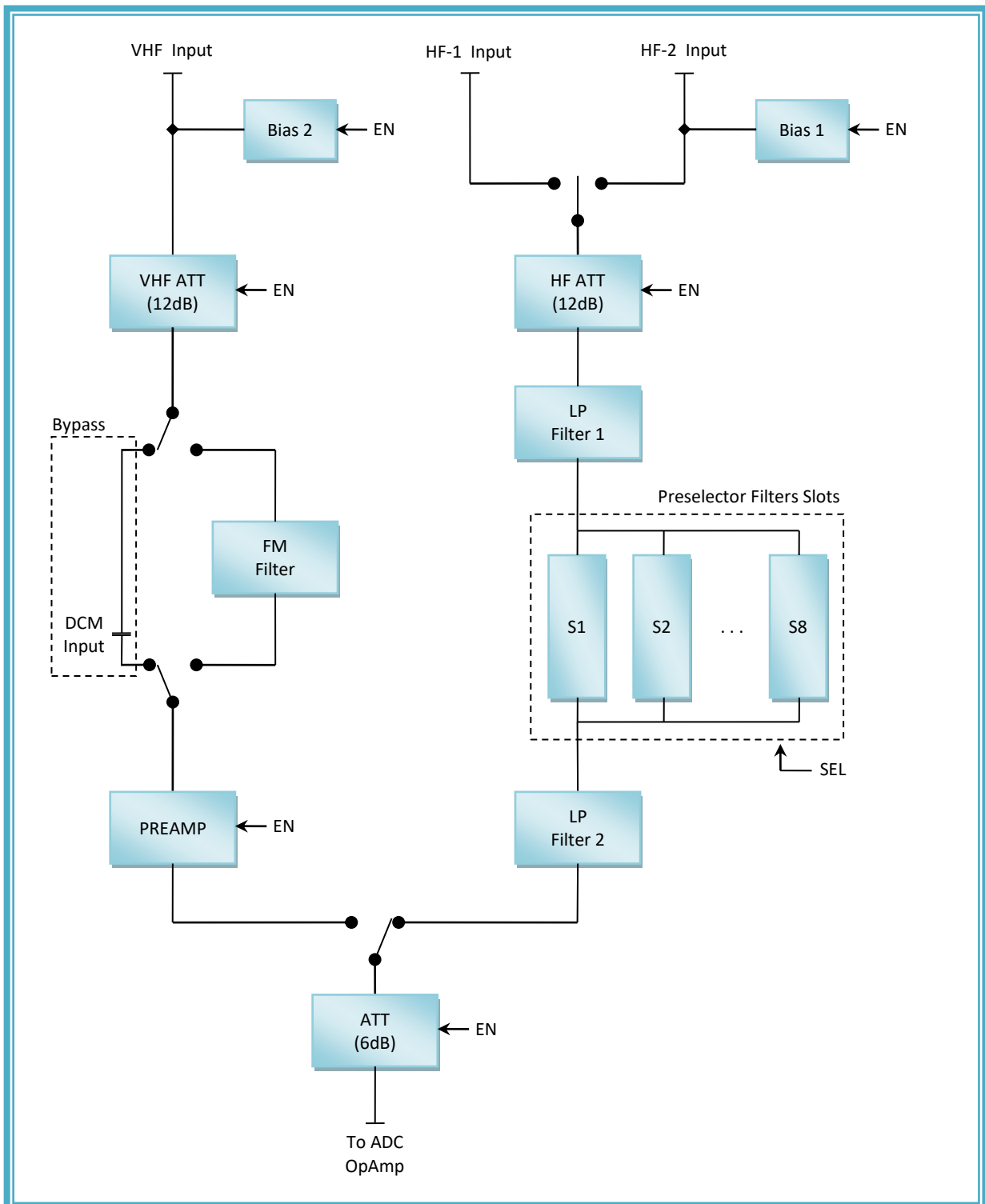

2 Panels Description

2.1 Front Panel Description

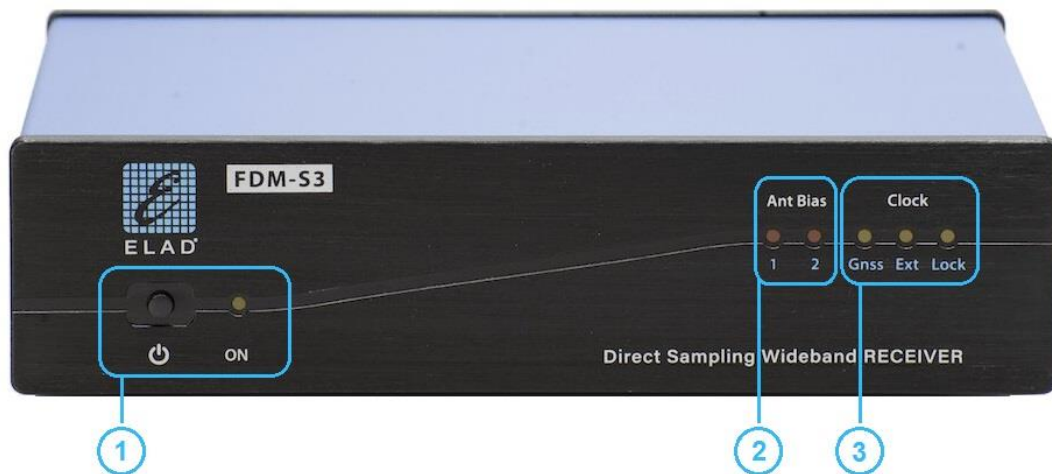

1 – Power button / power led

Press the power button to turn the FDM-S3 on/off. The power led lights up when the FDM-S3 is powered.

2 – Antennas biases leds

These leds turn on when the related bias feature is activated:

- led 1 for the HF-2 input,
- led 2 for the VHF input or for the RF-IN input,

see rear panel description for inputs location.

Biases are current limited however avoid to use biases with short circuited antennas.

3 – Clock leds

Clock leds give information about the in use reference clock:

- No leds on: no reference is used,
- **Gnss** led on: *Gnss (global navigation satellite system)* is used as reference,
- **Ext** led on: 10MHz external source is used as reference.

When a reference is used the **Lock** led turns on when the Reference Clock Manager Module of the FDM-S3 is locked onto the reference.

2.2 Rear Panel Description

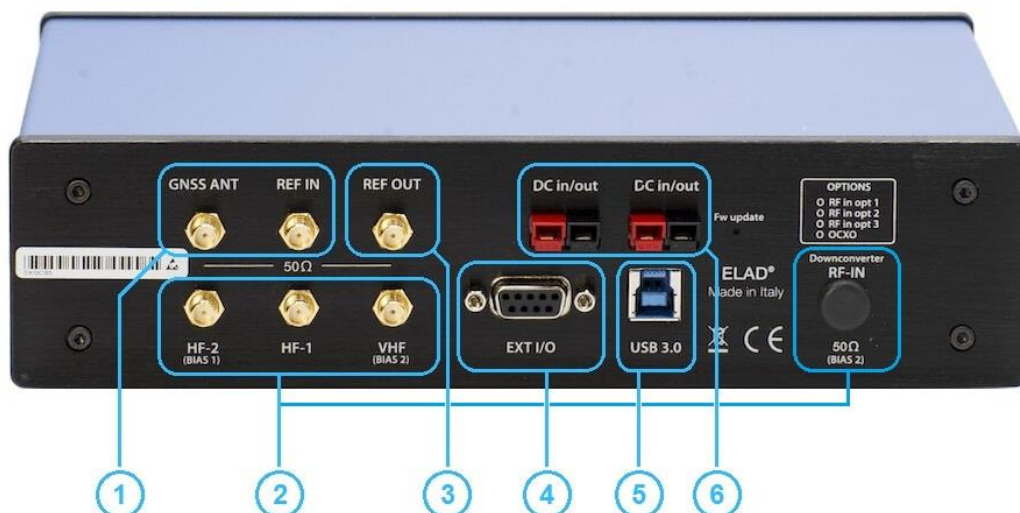

1 – Reference clock inputs (SMA connectors)

GNSS ANT is the input where connect a Gnss (*global navigation satellite system*) antenna. A voltage of 3.3Vdc is supplied on this connector, maximum deliverable current 50mA. The Gnss antenna is not supplied with all versions, please check ELAD websites for details.

REF IN is the input for a 10MHz/0dBm reference signal.

Reference clock activation is automatic, just connect the Gnss antenna or provide a 10MHz signal. If both inputs are used priority is given to the 10MHz signal (**REF IN**).

2 – RF antennas inputs (SMA connectors)

The FDM-S3 has four antenna connectors:

- **HF-1** for HF bands and the 50MHz band,
- **HF-2** (*with bias 1 feature*) for HF bands and the 50MHz band,
- **VHF** (*with bias 2 feature*) for frequencies over 54MHz,
- **RF-IN** (*with bias 2 feature*) for frequencies over 108MHz with the Downconverter Module activated.

3 – Clock reference output (SMA connector)

A 10MHz reference signal is always supplied on this output.

TCXO version: square wave type waveform of about 1.3Vpp.

OCXO version: sine wave of about 2.8Vpp.

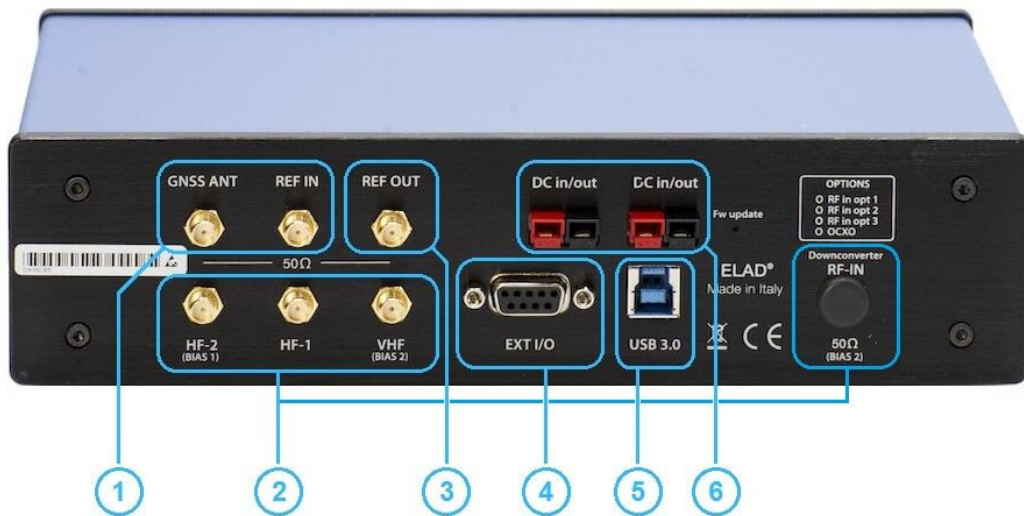

4 – EXT I/O

External Hardware Input/Output DB9 connector, used to connect future external hardware. This is NOT a serial port.

5 – USB 3.0 connector

USB 3.0 type B connector for computer connection.

The FDM-S3 has only one USB connector but provides three USB connections to:

- the ELAD FDM-S3 sampler,
- the USB COM Port of the Reference Clock Manager Module,
- the USB COM Port of the internal Gnss (*global navigation satellite system*) module.

6 – Power supply connectors

Powerpole connectors type, both may be used indistinctly, they are connected inside in parallel. Provide a typical voltage of 13.8Vdc to power the FDM-S3.

3 Optional Preselector Filters

The FDM-S3 has **eight slots** for preselector filters, also simply called preselectors or filters. These filters are **optional** and therefore not required for operation, only the included bypass filter is needed as shown in the picture below. Filters are connected to the HF-1 and HF-2 inputs where the allowed frequency range is from 9kHz to 54MHz.



To change the preselector filters configuration remove the top cover of the FDM-S3 and the preselector filters shield as shown in the picture above. Insert the desired filters, take note of filters positions and then replace the shield and the cover.

To enable the new configuration, open the **Setup** window of the FDM-SW2 software, and fill the **preselector configuration** tab with the correct data.

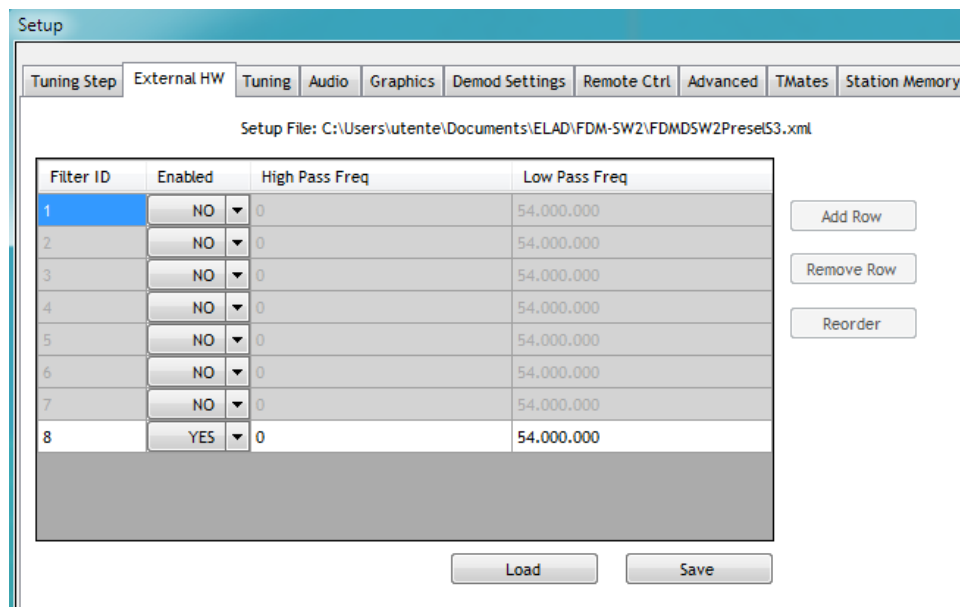

3.1 List of Available Filters

The following table presents the filters available on ELAD websites.

Filter Code	Description
FBPY *	Bypass board
FLP05M-1	500kHz Low-Pass Filter
FHP05M-1	500kHz High-Pass Filter
FHP1M7-1	1700kHz High-Pass Filter
FBP160-1	160 meters Band-Pass filter
FBP80-1	80 meters Band-Pass filter
FBP40-1	40 meters Band-Pass filter
FBP30-1	30 meters Band-Pass filter
FBP20-1	20 meters Band-Pass filter
FBP17-1	17 meters Band-Pass filter
FBP15-1	15 meters Band-Pass filter
FBP12-1	12 meters Band-Pass filter
FBP1321	13-21MHz Band-Pass filter
FBP2135	21-35MHz Band-Pass filter
FBP0530	0.05-30MHz Band-Pass filter set
FPCB-B3 **	Printed circuit board of B3 type filter
FPCB-H5 **	Printed circuit board of H5 type filter

* The bypass board is supplied with the FDM-S3.

** Only printed circuit board for self-built filters. The schematics are available online.

3.2 Slots Access

To access filters slots, follow these steps.

1. Loosen the rear panel.

To do this; loosen the 4 screws that secure the rear panel, loosen the 6 nuts of the SMA connectors and remove the 2 screws of the DB9 connector.



2. Remove the top cover.

Once the screws have been loosened, move the rear panel slightly outwards in order to remove the top cover. Attention, the bottom cover will also be free from the frame.



3. Remove the filters shield.

Remove the 5 screws that secure the filters shield and remove the shield. The filter slots are now accessible.

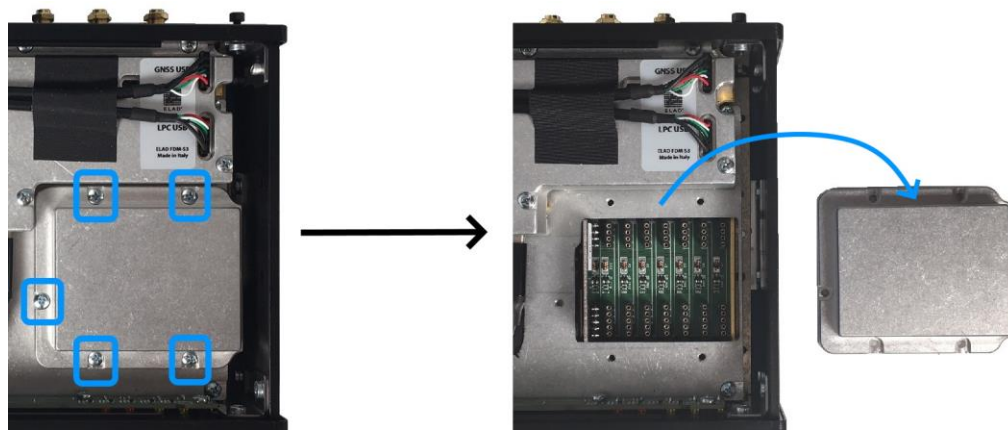

To close the FDM-S3 proceed in the opposite way, put back the filters shield and its screws, put back the top and bottom covers, put back the rear panel, tighten the screws and nuts of the SMA connectors.

3.3 Inserting Filters

The filters must be inserted by **identifying the number of the slot** where each single filter is inserted, this is because the configuration chosen for the filters is validated in the FDM-SW2 software indicating the slots used. The following picture shows the numbering of the FDM-S3 filter slots.

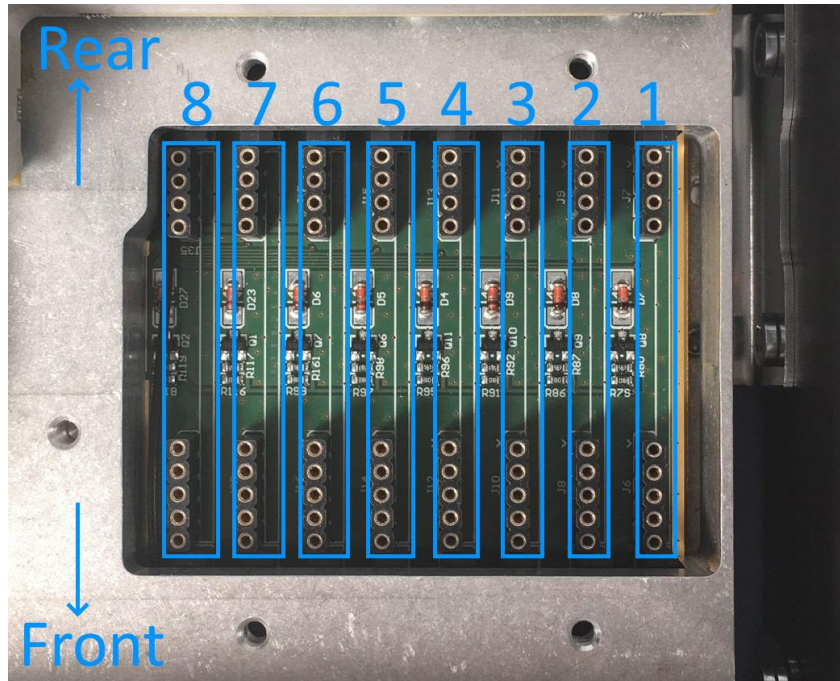

The following pictures show several cases of filters inserted, with from left to right:

- two filters inserted in slots 6 and 8,
- six filters inserted in slots 1, 2, 4, 5, 7 and 8,
- all 8 filters inserted.

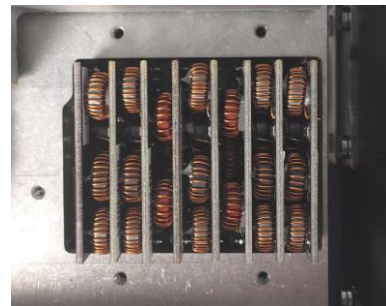
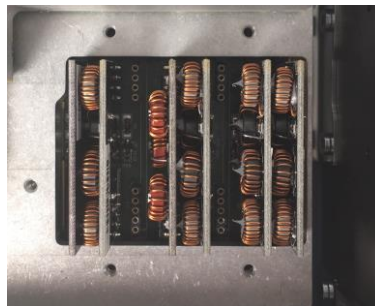
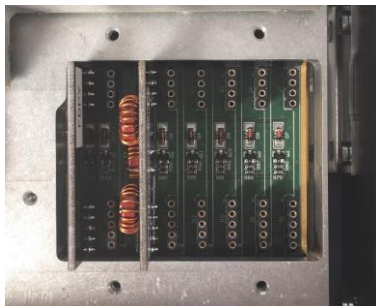

To decide which filter to use according to the tuned frequency, the FDM-SW2 software analyzes the configuration starting from slot number 1. It is therefore important to **insert the bypass in the last slot used** to have it chosen as the reception path if no other filter is enabled for the current tuning frequency.

The FDM-S3 leaves the factory with a bypass board inserted in slot number 8.

3.4 Enabling the Configuration

To enable the new configuration, open the **Setup** window of the FDM-SW2 software, and fill the **preselector configuration** tab with the correct data. The **Filter ID** field is the slot number. The image below shows the default configuration.

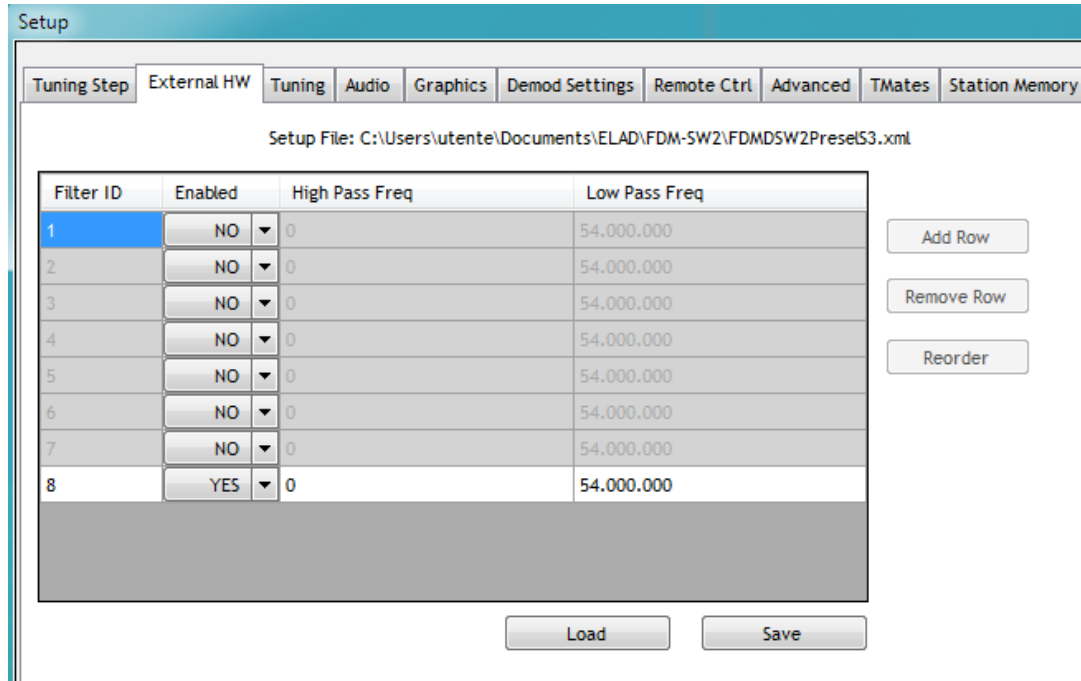

To enable another filter, for example the FBP20-1 filter for the 20m band, proceed as follows:

- choose a position lower than the one of the bypass board, for example number 6,
- in the enabling drop-down menu, change from NO to YES,
- enter the frequency limit values for the filter, for this example 14MHz and 14.35MHz.

The following image shows the **preselector configuration** tab before and after making the change.



4 USB COM Ports

As stated before in this user manual the FDM-S3 presents two USB COM ports:

- the COM port of the Reference Clock Manager Module (RCMM) where some information about status are supplied with a proprietary protocol,
- the COM port of the internal Gnss (*global navigation satellite system*) module, where data are sent using the NMEA protocol.

Use the Windows Device Manager to identify the COM ports.

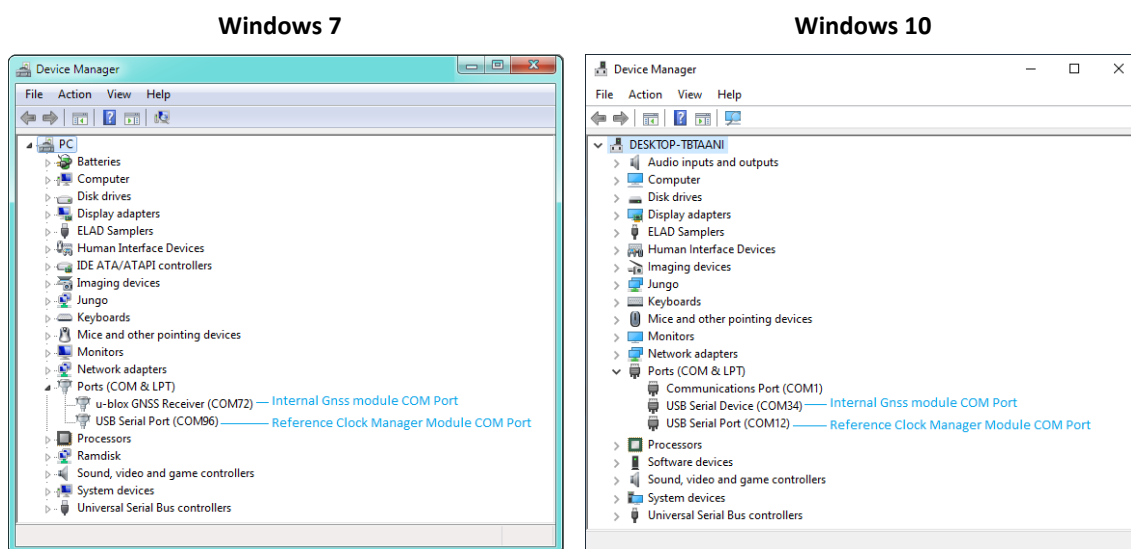

NB: on Windows 10 the COM port of the internal Gnss is seen as “USB Serial Device”.

4.1 Reference Clock Manager Module COM Port

To view status information, open this COM port with a Serial Terminal Software like Realterm, baud rate is 115200 and settings are 8N1. A status information string is sent every second, the two main data available are the **reference clock used** and the **lock state**. Below is an example:

```
00153|0100000000|0100000000|0000|34953|x800092y|0003|+0000|00002|00003| = |00000
```

Reference clock used, identified by **x** in the string above:

- 'I': **Internal**, factory calibration is used,
- 'G': **Gnss**, GNSS ANT reference clock input is used,
- 'E': **Ext**, REF IN reference clock input is used,
- 'H': **In Hold**, one of the reference clock inputs was used but they are now disconnected.

Lock state, identified by **y** in the string above:

- '0': Reference Clock Manager Module **not locked** on the reference clock input,
- '1': Reference Clock Manager Module **locked** on the reference clock input.

Some CAT style commands can also be sent to have information about the RCMM, like:

- get serial number: SN;
- get hardware version: HV;
- get firmware version: VSM;

4.2 Internal Gnss module COM Port

Data sent on this COM port use the NMEA protocol, a Serial Terminal Software like Realterm can be used to receive the data. Baud rate is 115200 and settings are 8N1. Here an example:

```
$GNRMC,132932.00,A,4559.82760,N,01227.92444,E,0.030,,061020,,D*6A
$GNVTG,,T,,M,0.030,N,0.055,K,D*3B
$GNGGA,132932.00,4559.82760,N,01227.92444,E,2,12,0.69,103.2,M,44.8,M,,0000*42
$GNGSA,A,3,04,22,03,07,02,17,26,19,09,06,,1.29,0.69,1.09*16
$GNGSA,A,3,73,87,70,86,71,80,,,,,1.29,0.69,1.09*1D
$GPGSV,4,1,14,02,23,315,33,03,34,107,31,04,60,055,21,06,57,273,27*7B
$GPGSV,4,2,14,07,29,180,39,09,76,268,34,16,05,086,23,17,06,231,08*73
$GPGSV,4,3,14,19,13,245,18,22,15,115,27,26,09,052,28,30,04,195,*75
$GPGSV,4,4,14,36,34,154,38,49,37,190,41*71
$GLGSV,3,1,11,70,32,069,27,71,66,356,34,72,32,286,,73,31,122,34*62
$GLGSV,3,2,11,74,02,162,,79,04,013,09,80,35,059,31,85,02,193,*65
$GLGSV,3,3,11,86,35,230,27,87,33,316,27,88,06,344,*52
$GNGLL,4559.82760,N,01227.92444,E,132932.00,A,D*75
```

Alternatively, open the COM Port with the software u-center from u-blox, it can display various information about the Gnss module.

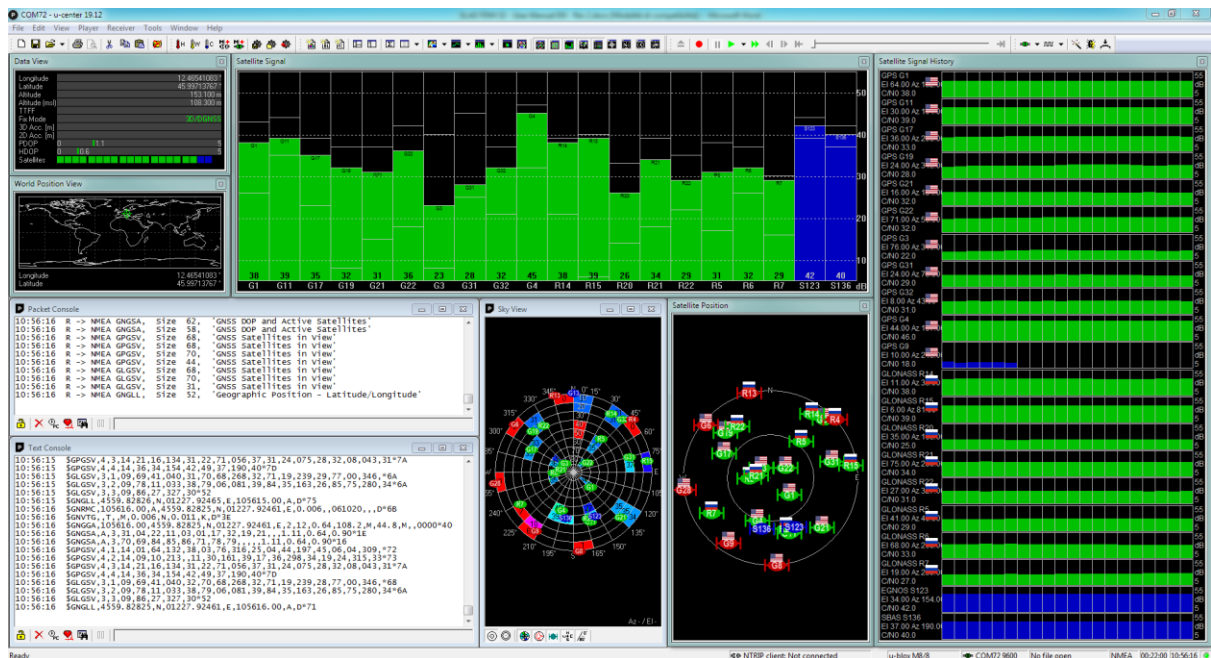

Also, other software which use the NMEA protocol may be used.

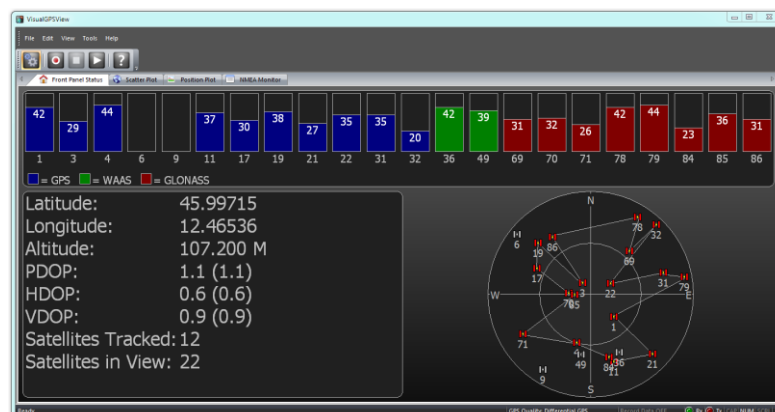

5 Order Options

5.1 Oscillator Version

The FDM-S3 is shipped in one of these two versions:

- version with TCXO (*Temperature Compensated Crystal Oscillator*),
- version with OCXO (*Oven Controlled Crystal Oscillator*).

The installed version can be factory changed by replacing the **Reference Clock Manager Module** (RCMM).

5.2 Preselector Filters

The FDM-S3 is shipped with one (1) bypass filter. Up to eight preselector filters can be self-installed. Refer to ELAD websites for a list of available filters.

5.3 Downconverter Module

The FDM-S3 Downconverter Module (DCM) allows to extend frequency coverage range over 108MHz. The FDM-S3 can be shipped with this option if requested. ~~Furthermore, the Downconverter Module can also be installed independently by the customer.~~

Technical Specifications

ELAD FDM-S3 - TECHNICAL SPECIFICATIONS			Rev. 2 - 10/2020
GENERAL	Frequency Coverage	HF + 50MHz Band + FM Band (9KHz ÷ 108MHz) using Direct Sampling Mode, Undersampling Mode and Variable Sample Rate (122.88MHz/98.304MHz) Extended frequency range with Downconverter Option or Bypass for Experimental Use	
	Antenna Connectors	HF1: HF + 50MHz Band input, SMA connector (50Ω) HF2: HF + 50MHz Band input, SMA connector (50Ω), activatable BIAS1 for external device VHF: VHF Band input, SMA connector (50Ω), activatable BIAS2 for external device	
	Temperature Range	-10÷40°C / 14÷104°F	
	PC Interface	High-Speed USB 3.0	
	Power Supply	DC 8-16V (not included)	
	Power Consumption	TCXO version : less than 9W (12V-700mA) OCXO version : less than 15W (12V-1100mA)	
	External I/O Connector	DB9 connector for future use (this is not a serial port)	
	Absolute Maximum RF Input Level	+20 dBm	
	Dimensions (W x H x D)	230 x 60 x 155 mm / 9 x 2.4 x 6.1 in	
	Weight	2.15 kg / 4.74 lb (all versions, without internal Downconverter)	
	HF + 50MHz Band RECEIVER	Test Configuration	Direct Sampling Mode / 192KHz Bandwidth / 122.88MSPS ⁽²⁾ with 16 bit per sample
Sensitivity		Typical: -122 dBm (CW, BW 500 Hz, 10 dB (S+N)/N) -110 dBm (CW, BW 500 Hz, 10 dB (S+N)/N) Attenuator 12dB On	
3rd Oder Intercept Point		Typical: +30 dBm @ 14 MHz, Spacing 10 kHz Dithering On	
Blocking Gain Compression		Typical: > 115 dB @ 10 MHz, Spacing 2 kHz, CW, BW 500 Hz	
Noise Floor (MDS)		Typical: -132 dBm @ 14 MHz, CW, BW 500 Hz, NR ⁽¹⁾ Off -138 dBm @ 14 MHz, CW, BW 500 Hz, NR ⁽¹⁾ On -129 dBm @ 14 MHz, CW, BW 500 Hz, NR ⁽¹⁾ Off Dithering ON -126dBm @ 14 MHz, CW, BW 500 Hz, NR ⁽¹⁾ Off Attenuator 6dB On -120 dBm @ 14 MHz, CW, BW 500 Hz, NR ⁽¹⁾ Off Attenuator 12dB On -114 dBm @ 14 MHz, CW, BW 500 Hz, NR ⁽¹⁾ Off Attenuator 18dB On -130 dBm @ 50 MHz, CW, BW 500 Hz, NR ⁽¹⁾ Off -136 dBm @ 50 MHz, CW, BW 500 Hz, NR ⁽¹⁾ On	
Clipping Level		-5 dBm @ 14 MHz, +1 dBm @ 14 MHz Attenuator 6 dB On +7dBm @ 14 MHz Attenuator 12 dB On +13 dBm @ 14 MHz Attenuator 18 dB On	
Internal Spurious Carriers		Typical: < -125dBm	
VHF Band RECEIVER		Test Configuration	Undersampling Mode / 192KHz Bandwidth (unless otherwise stated) / 122.88MSPS ⁽²⁾ with 16 bit per sample
	Sensitivity (WBFM)	Typical (384KHz Bandwidth): 0.98 µV S/N 30 dB @ 91.1 MHz Preamplifier On 0.87 µV S/N 26 dB @ 91.1 MHz Preamplifier On 0.70 µV S/N20 dB @ 91.1 MHz Preamplifier On 5.8 µV S/N 30 dB @ 91.1 MHz Preamplifier Off 5.3 µV S/N 26 dB @ 91.1 MHz Preamplifier Off 4.2 µV S/N 20 dB @ 91.1 MHz Preamplifier Off 11 µV S/N 30 dB @ 91.1 MHz Attenuator 6 dB On 24 µV S/N 30 dB @ 91.1 MHz Attenuator 12 dB On 50 µV S/N 30 dB @ 91.1 MHz Attenuator 18 dB On	
	3rd Oder Intercept Point	Typical: +26dBm @ 91.1 MHz, Spacing 50 kHz Preamplifier Off	
	Noise Floor (MDS)	Typical: -138 dBm @ 91.1 MHz, CW, BW 500 Hz, NR ⁽¹⁾ Off Preamplifier On -129 dBm @ 91.1 MHz, CW, BW 500 Hz, NR ⁽¹⁾ Off Preamplifier Off -123 dBm @ 91.1 MHz, CW, BW 500 Hz, NR ⁽¹⁾ Off Preamplifier Attenuator 6dB On -117 dBm @ 91.1 MHz, CW, BW 500 Hz, NR ⁽¹⁾ Off Preamplifier Attenuator 12dB On -111 dBm @ 91.1 MHz, CW, BW 500 Hz, NR ⁽¹⁾ Off Preamplifier Attenuator 18dB On	
	Clipping Level	Typical: -23 dBm @ 91.1 MHz Preamplifier On -4 dBm @ 91.1 MHz Preamplifier Off +2 dBm @ 91.1 MHz Attenuator 6 dB On +8 dBm @ 91.1 MHz Attenuator 12 dB On +14 dBm @ 91.1 MHz Attenuator 18 dB On	
	Internal Spurious Carriers	Typical: < -130 dBm	
⁽¹⁾ Noise Reduction			
⁽²⁾ Mega Sample Per Second			
All stated specifications and other product information provided in this document are subject to change without notice or obligation.			

Product Warranty

ELAD S.r.l. warrants the FDM-S3 for a period of 2 years inside Europe, and for a period of 1 year outside Europe unless otherwise specified. Warranty begins from the purchase date. All FDM-S3 will be repaired or replaced due to malfunction resulting from no fault of the end user. This warranty covers normal intended usage of the product and does not cover misuse, abuse, accidents, viruses, incorrect or overloaded computer installations, unauthorized service parts or the combination of other unauthorized branded products used in conjunction with the FDM-S3.

Declaration of Conformity (EC)

The product marked as

FDM-S3

manufactured by

Manufacturer: ELAD S.r.l.
Address: Via Col De Rust, 11
I-33070 CANEVA (PN)

is produced in conformity to the requirements contained in the following EC directives:

- Radio equipment Directive 2014/53/EU
- EMC Directive 2014/30/EU
- Low Voltage Directive 2014/35/EU
- RoHS Directive 2011/65/EU

The product conforms to the following product specifications:

Radio, Emissions & Immunity:

EN 301 489-1 V2.2.3 (2019-11)
EN 301 489-15 V2.2.1 (2019-04)
EN 301 783 V2.1.1 (2016-01)
EN 55032:2015/A11:2020
EN 55035:2017/A11:2020

Safety:

EN 62368-1:2014

and further amendments.

This declaration is under responsibility of the manufacturer

ELAD S.r.l.
Via Col De Rust, 11
I-33070 CANEVA (PN)

Issued by

Name: Franco Milan
Function: President of ELAD S.r.l.

CANEVA

Place

May, 18th 2021

Date

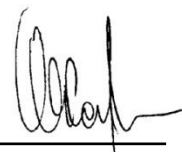

Signature

Declaration of Conformity (FCC)

The product marked as

FDM-S3

manufactured by

Manufacturer: ELAD S.r.l.
Address: Via Col De Rust, 11
I-33070 CANEVA (PN)

complies with the following requirements:

- FCC (Federal Communications Commission) Part 15.

Operation is subject to the following two conditions:

- (1) this device may not cause harmful interference,
- (2) this device must accept any interference received, including interference that may cause undesired operation.

NOTE: this equipment has been tested and found to comply with the limits for a Class B digital device, pursuant to Part 15 of the FCC Rules. These limits are designed to provide reasonable protection against harmful interference in a residential installation. This equipment generates, uses and can radiate radio frequency energy and, if not installed and used in accordance with the instructions, may cause harmful interference to radio communications. However, there is no guarantee that interference will not occur in a particular installation. If this equipment does cause harmful interference to radio or television reception, which can be determined by turning the equipment off and on, the user is encouraged to try to correct the interference by one or more of the following measures:

- reorient or relocate the receiving antenna,
- increase the separation between the equipment and receiver,
- connect the equipment into an outlet on a circuit different from that to which the receiver is connected,
- consult the dealer or an experienced radio/TV technician for help.

Changes or modification not expressly approved by the party responsible for compliance could void the user's authority to operate the equipment.

This product is distributed in USA by:

ELAD USA Inc.
618 Cummings Chapel Road
Ridgeville, SC 29472. USA

USA Sales Email : Sales@elad-usa.com
USA Support Email : Support@elad-usa.com
Phone: 312-320-8160